



SIM

**SERVICIOS DE INGENIERIA
Y MANUFACTURA**

Quienes somos

SIM es una empresa que nació en el año 2011 cuyo principal objetivo fue cubrir las necesidades de nuevos clientes enfocados a la integración y programación. El mercado de proyectos de el rango afín se veían a la alza.

El objetivo de nuestra empresa es facilitar la producción industrial utilizando nuestros diseños, así como ser aun mas competitivos en nuestra área empleando la gama de servicios con los que contamos.



Misión

Cumplir más allá de los estándares requeridos por nuestros clientes, actualizando nuestros diseños y métodos de trabajo, así como, alimentando nuestros conocimientos.



Visión

Ser una empresa reconocida por nuestro trabajo, ampliando nuestras fronteras para incrementar nuestra fuente de trabajo.



Servicios:

- ❑ Diseño.
- ❑ Manufactura.
- ❑ Programación.
- ❑ Automatización.
- ❑ Torneado.
- ❑ Soporte técnico.
- ❑ Herrería.
- ❑ Maquinado CNC.
- ❑ Soldadura TIG/MIG.
- ❑ Tratamientos térmicos en metales.
- ❑ Rectificado.

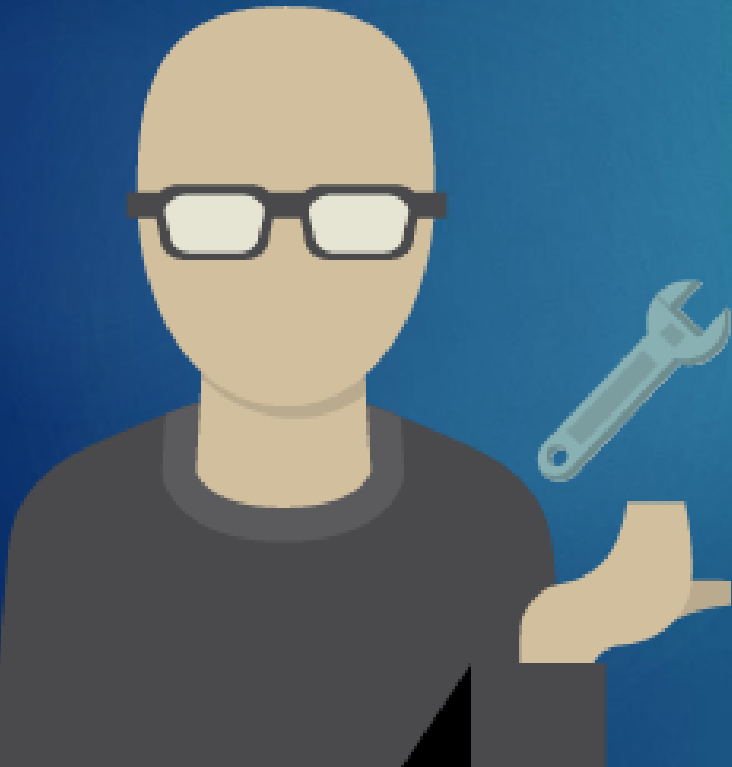

Valores

INTEGRIDAD

Solidaridad

Servicio

Optimismo

LEALTAD

INTEGRIDAD

Respeto

Compromiso

EFICACIA

Perseverancia

Responsabilidad

Nuestros clientes:

Valeo

Nidec

All for dreams

 **Scientific
Atlanta**

SIM

NICHIRIN

DELPHI
Automotive Systems

 **Visteon®**



VELCRO®

Portafolio



SERVICIOS DE INGENIERIA
Y MANUFACTURA

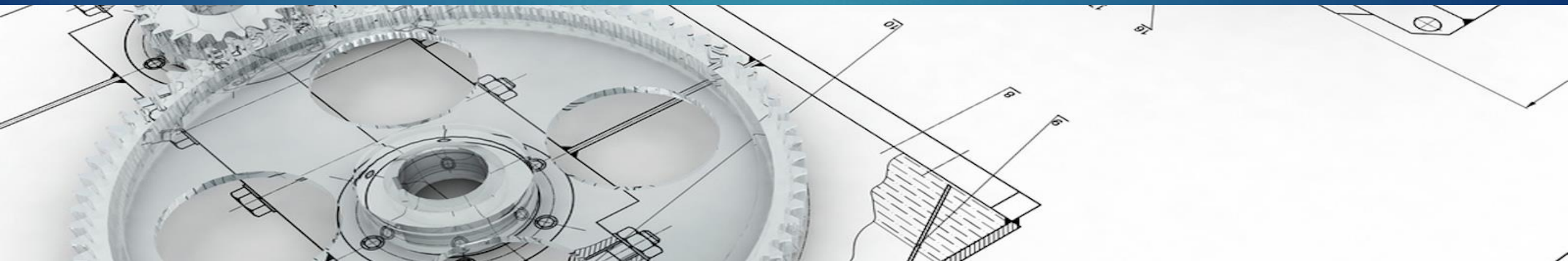

Proyecto: Reingeniería en cowell 20144

Cliente: Velcromex

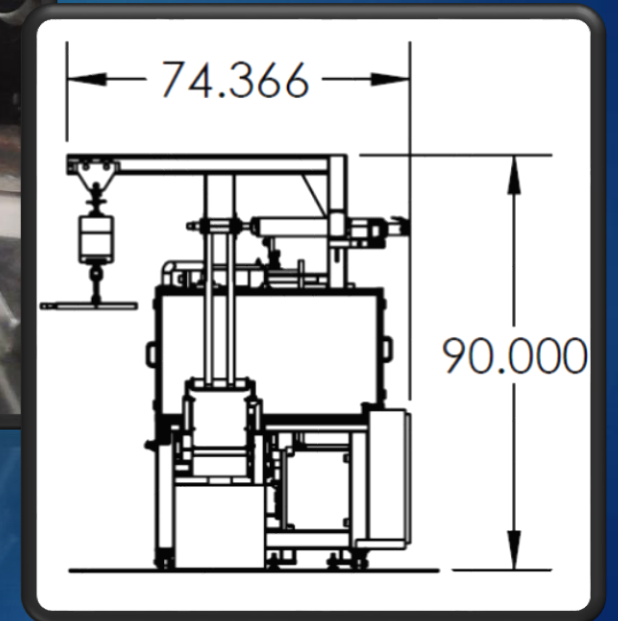
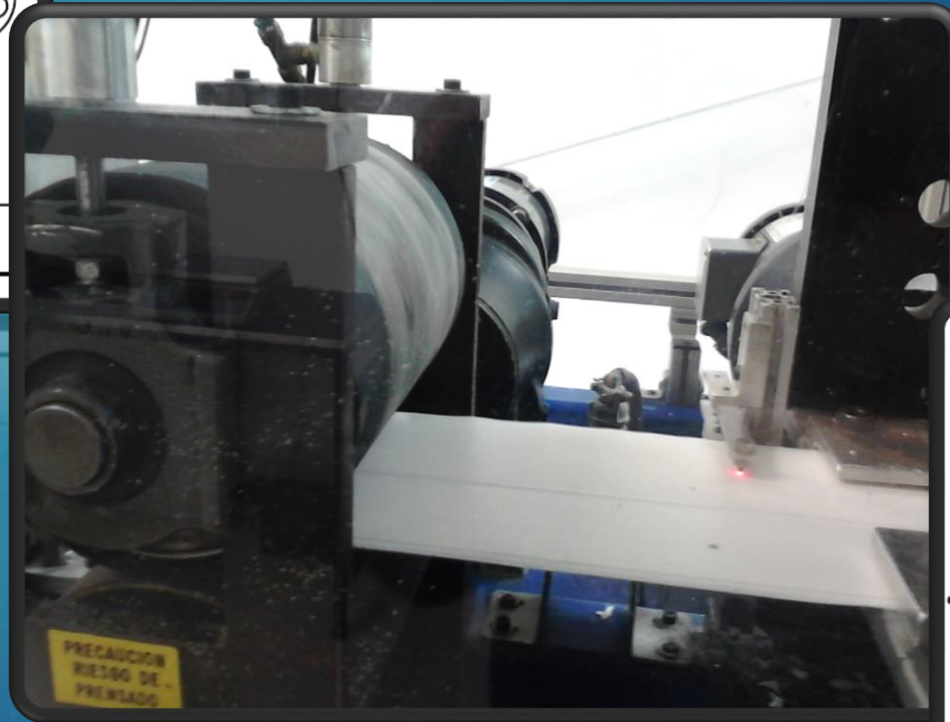
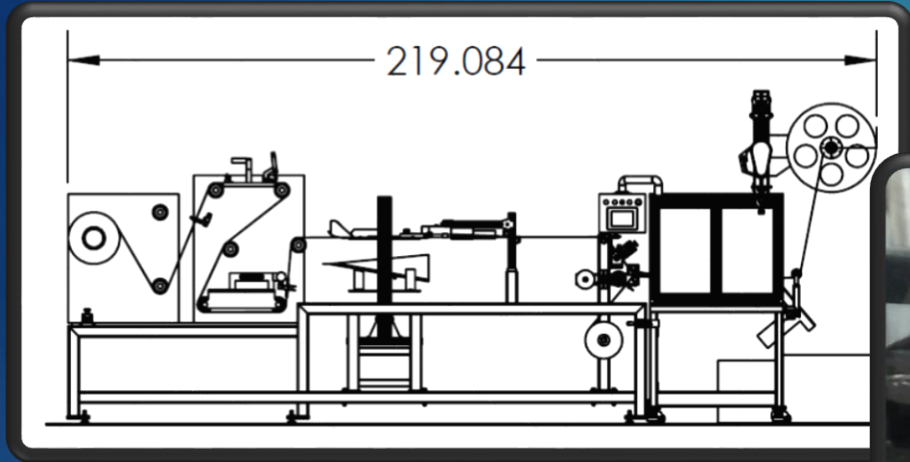



VISTEON

CLIENTE

Dispositivos Mesa Doble Panel

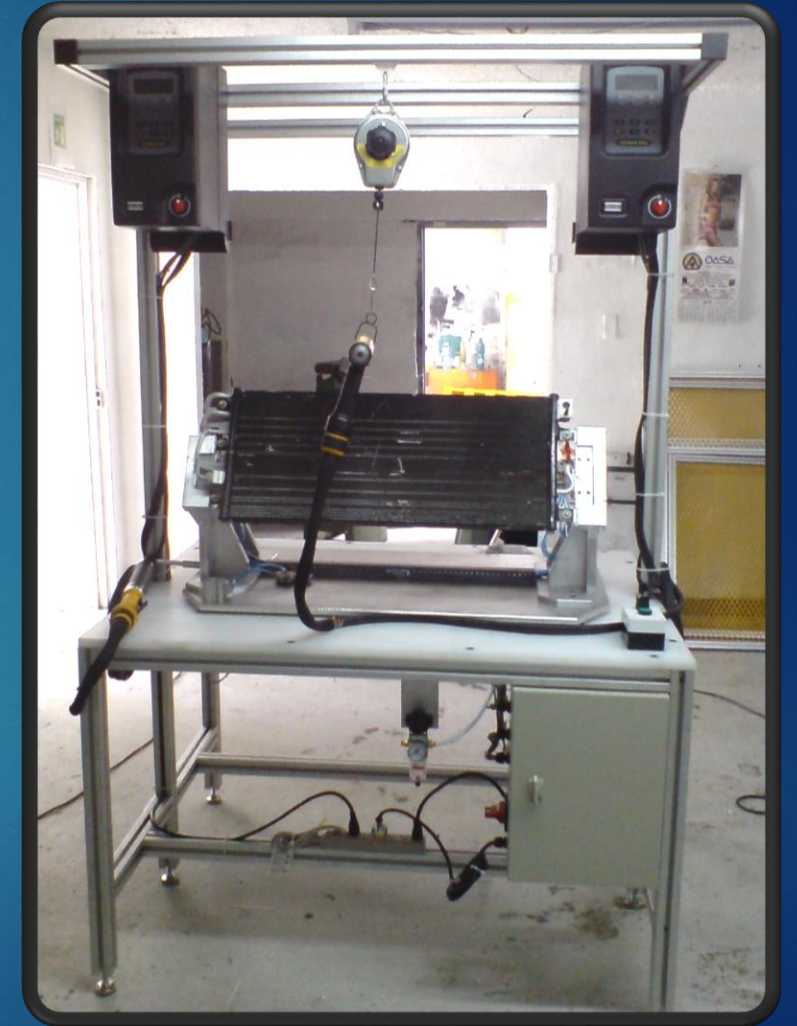
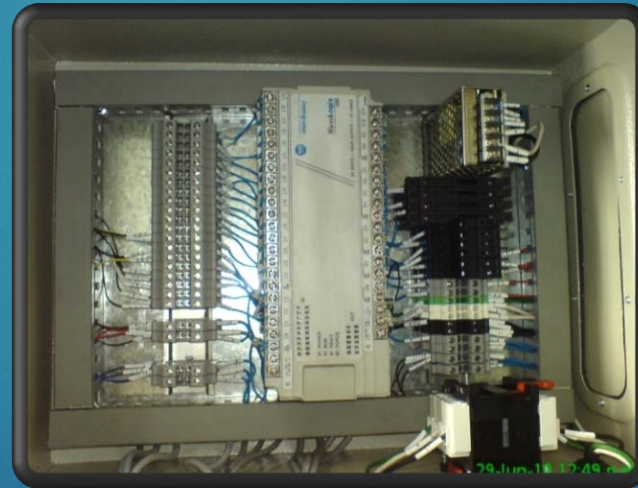
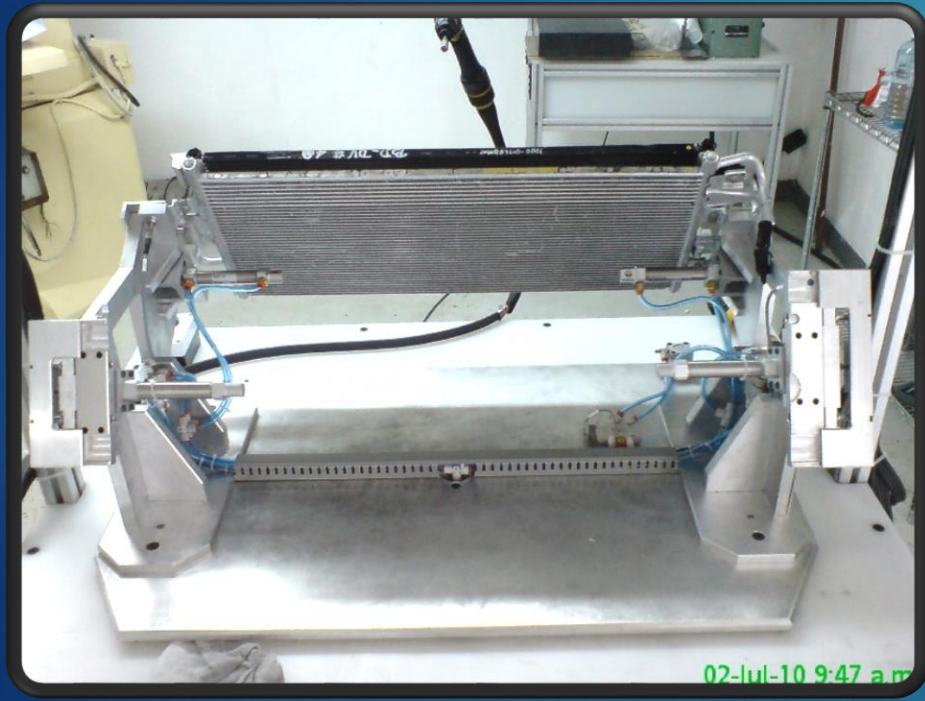

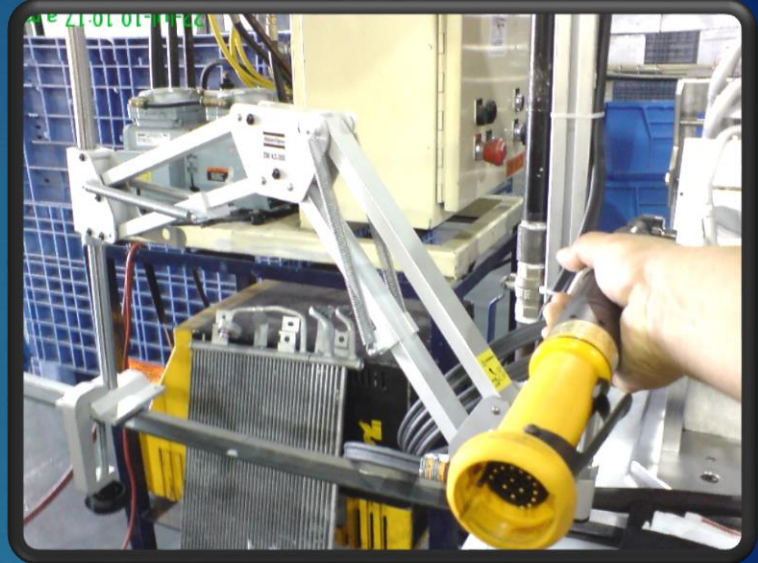

2024-10-9 9:49 a.m.
2024-10-9 9:49 a.m.

Dispositivo Mesa U502





**Scientific
Atlanta**

SCIENTIFIC ATLANTA

CLIENTE

Cortadora de Toroides

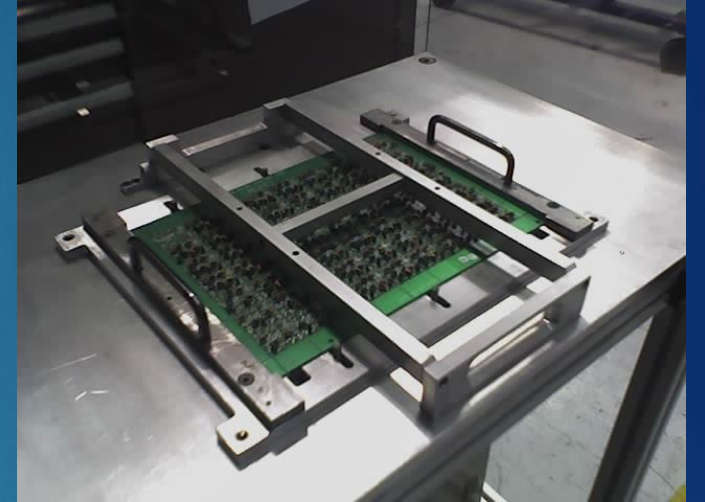

Prensa Fusibles

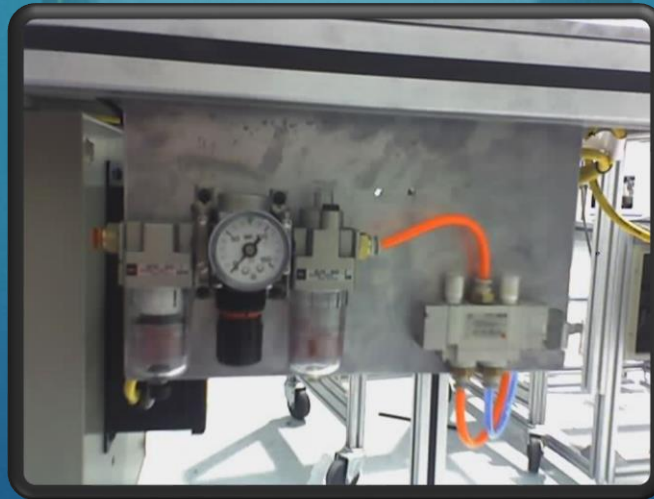
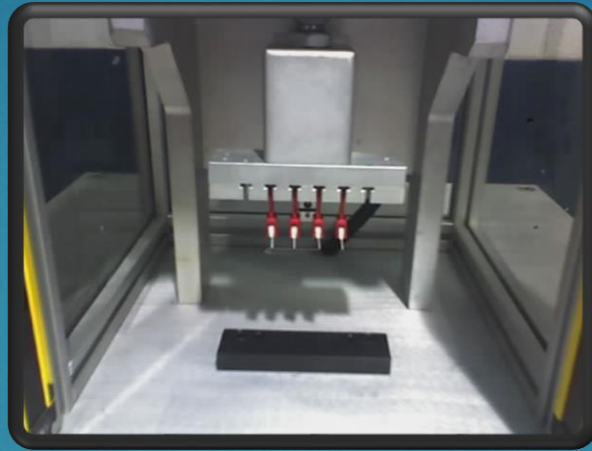



DELPHI

Automotive Systems

DELPHI

CLIENTE

TRENSADORA CABLE

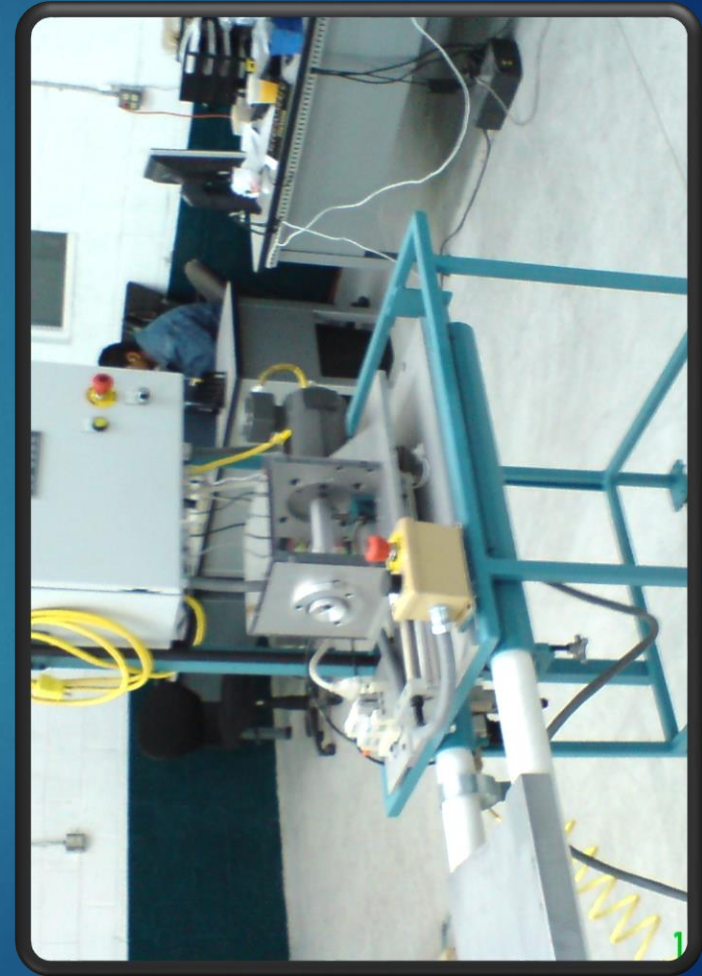

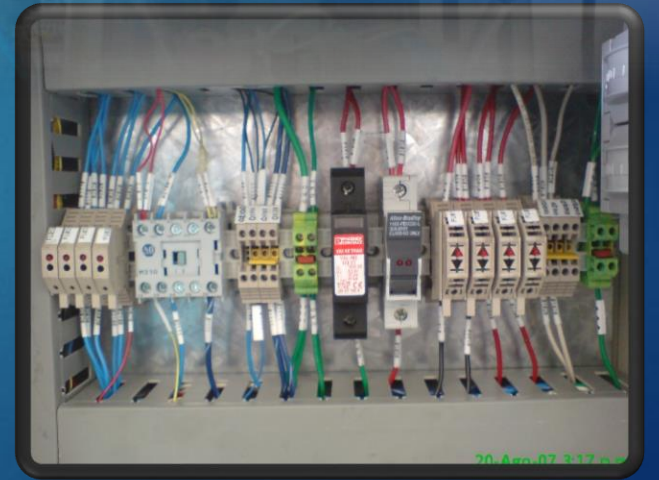
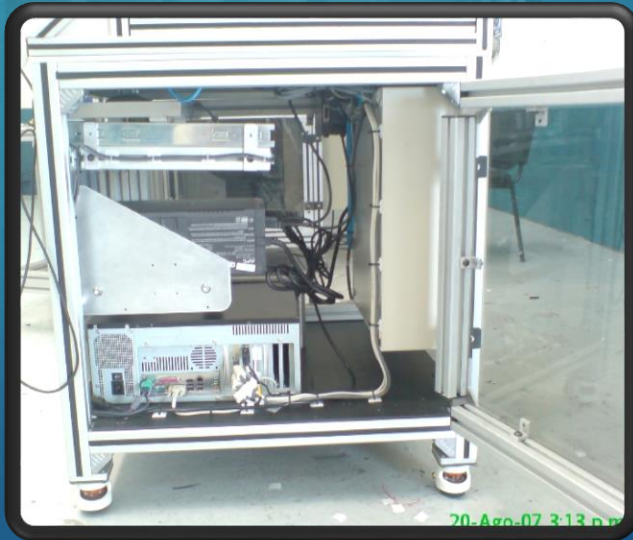
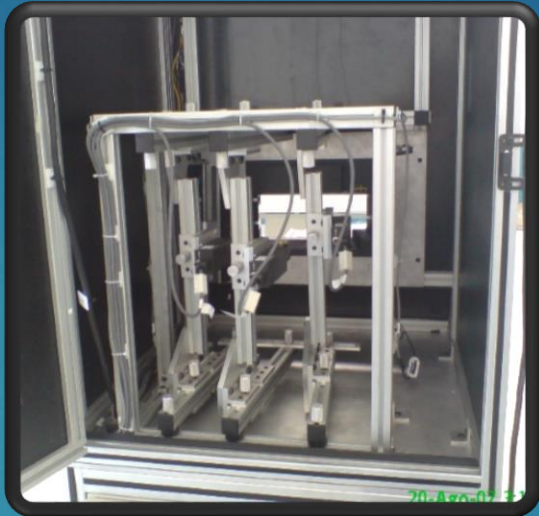



KSS
KEYSAFETY SYSTEMS

KEYSAFETY SYSTEMS

CLIENTE

Detector de Metales



Pocket

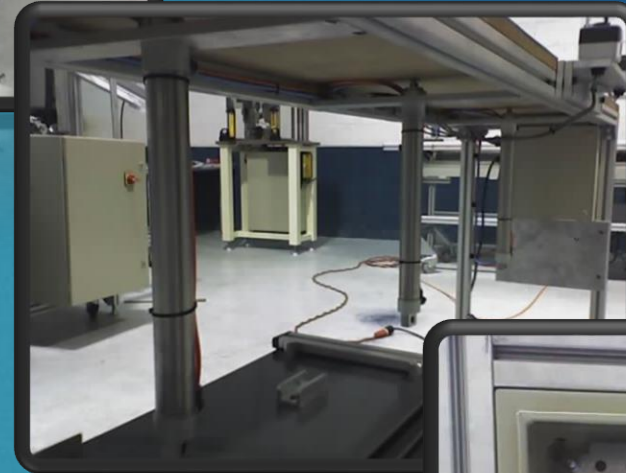



Nidec

All for dreams

Nidec
Cliente

Rack para materia prima

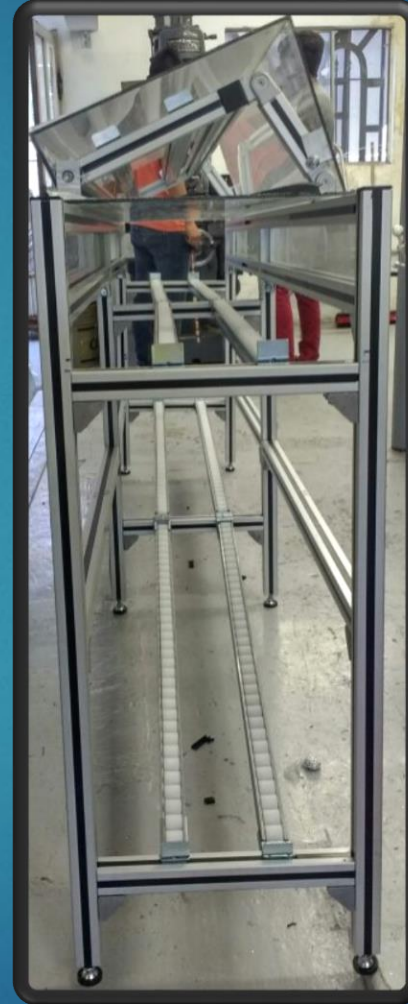
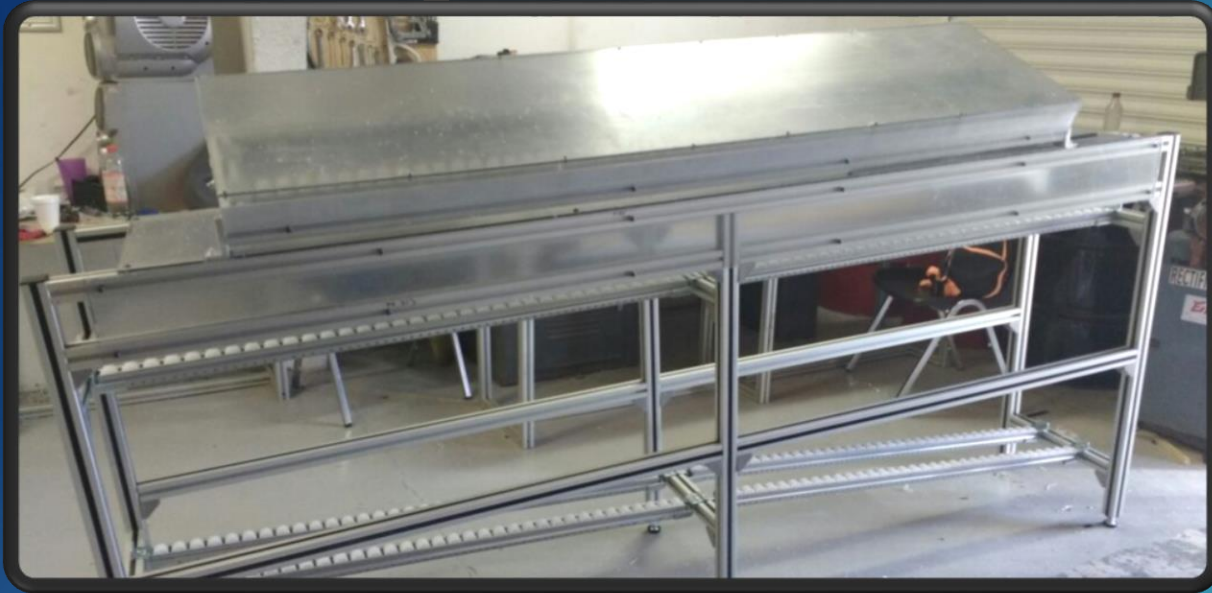

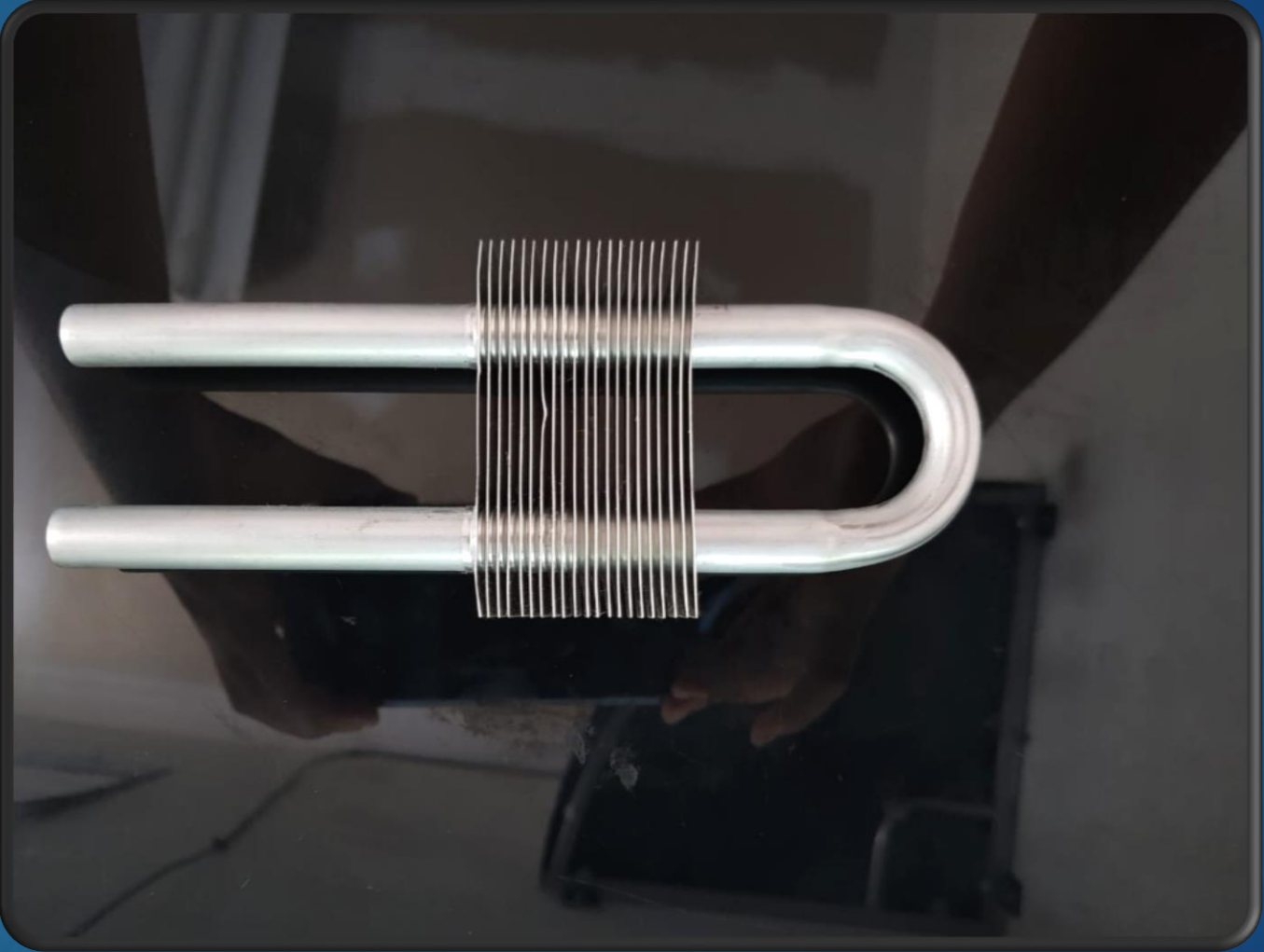



Valeo



Valeo
Cliente

**REUBICACION
DE FIXTURAS DE
ESTAMPADO
LINEA A-7**



FIXTURA PARA ENSAMBLE DE RESORTE Y C - BOW

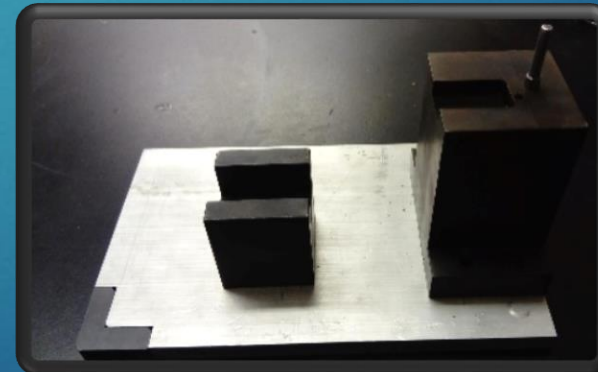
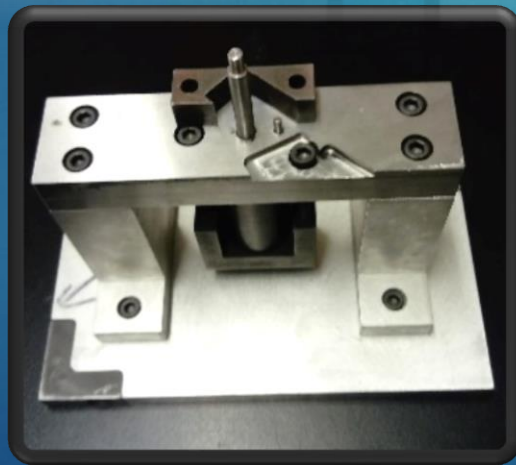
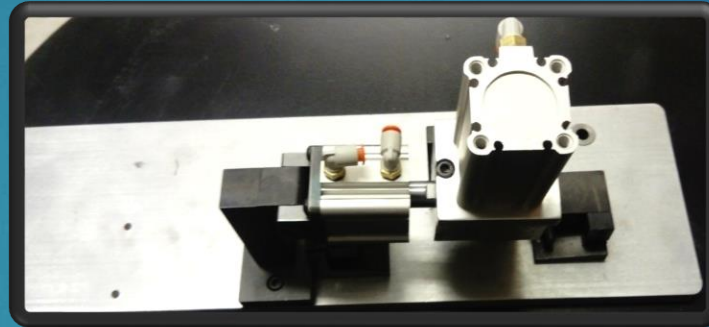
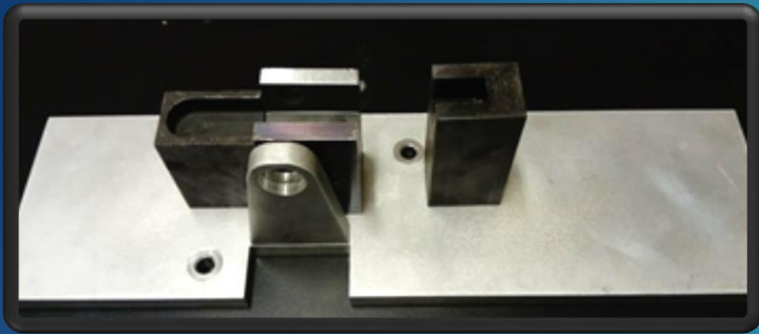

FIXTURA PARA
MONTAJE DE
MORDAZAS BR
BLOKE PARA
MORDAZAS DE
VARILLA



FIXTURAS PARA MONTAJE DE MOTOR PRUEBA DE WIPERS

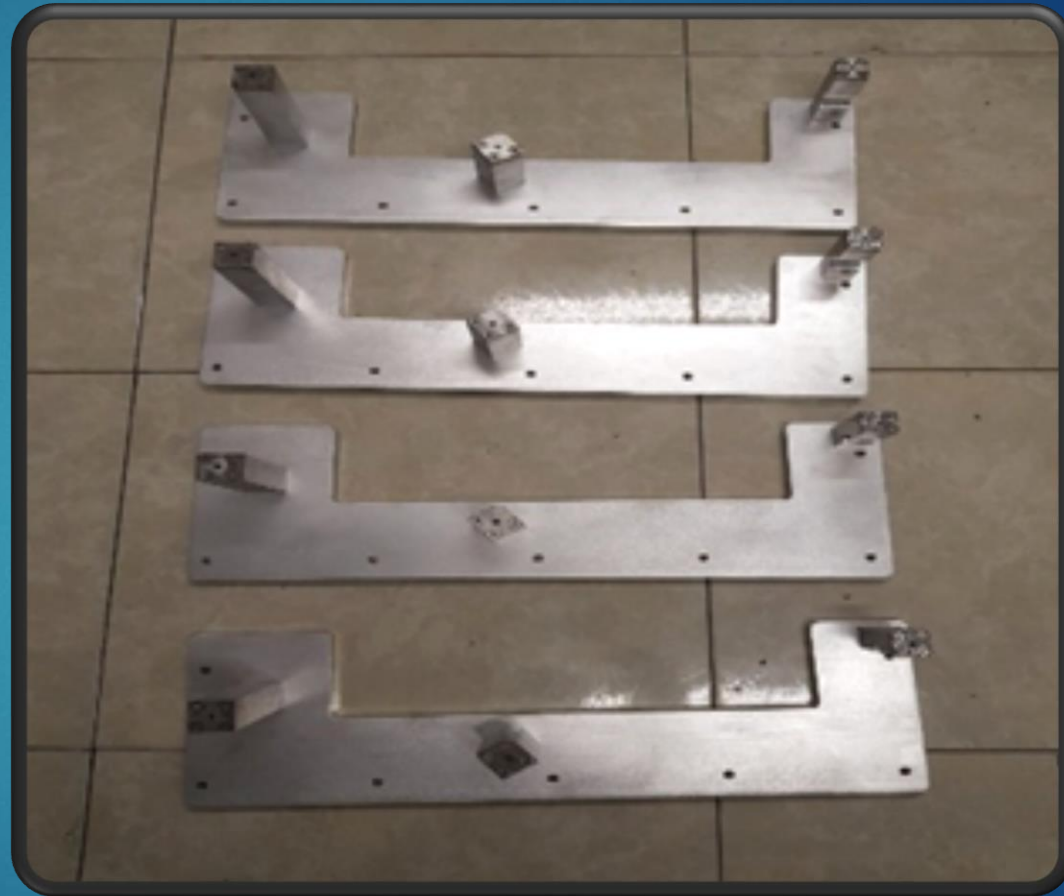

Fabricación de fixtura para jalón

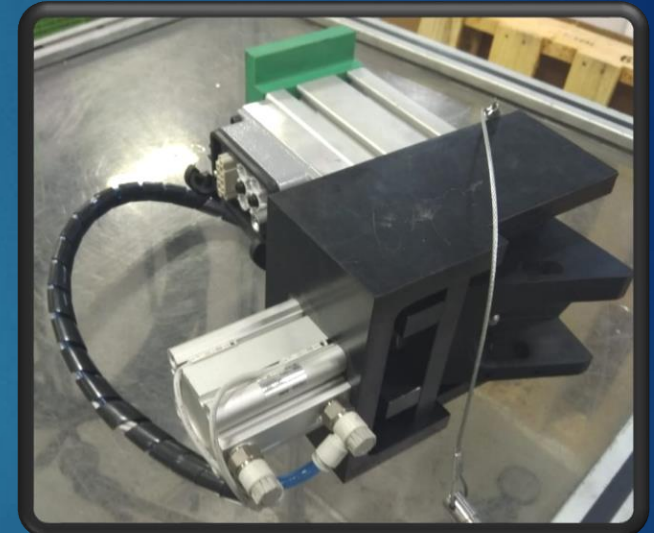
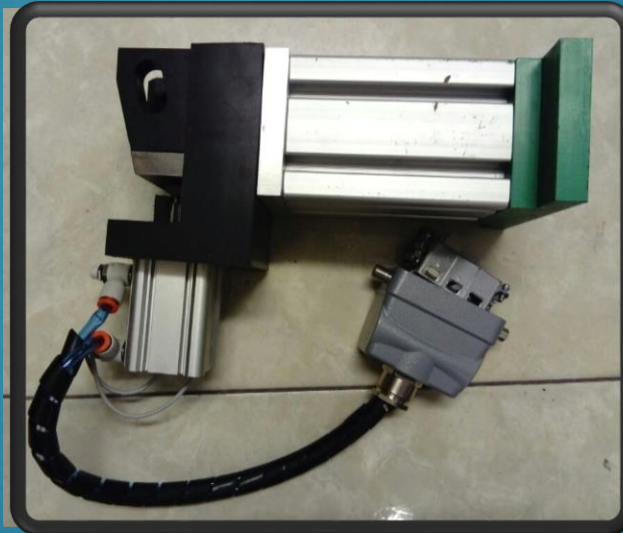
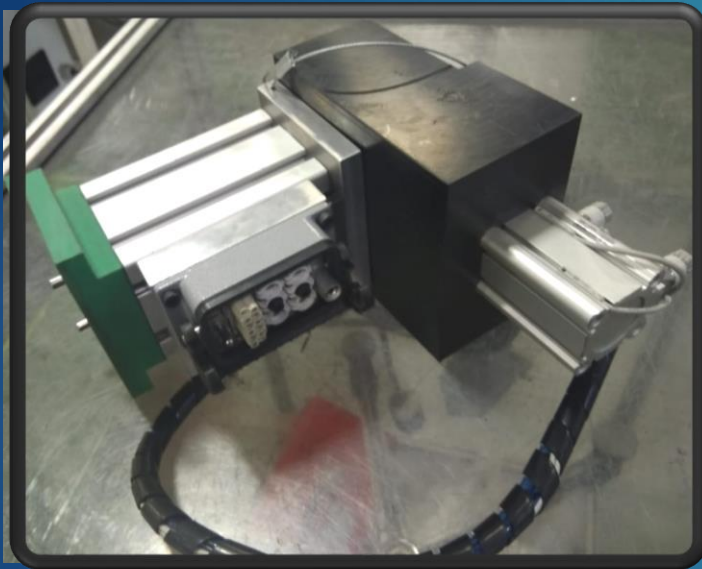

Integración de
modelo x247 lhd
rhd ds





Fabricación
de fixtura
para jalón

Integración De Modelo U625 Híbrido Driver En A-4

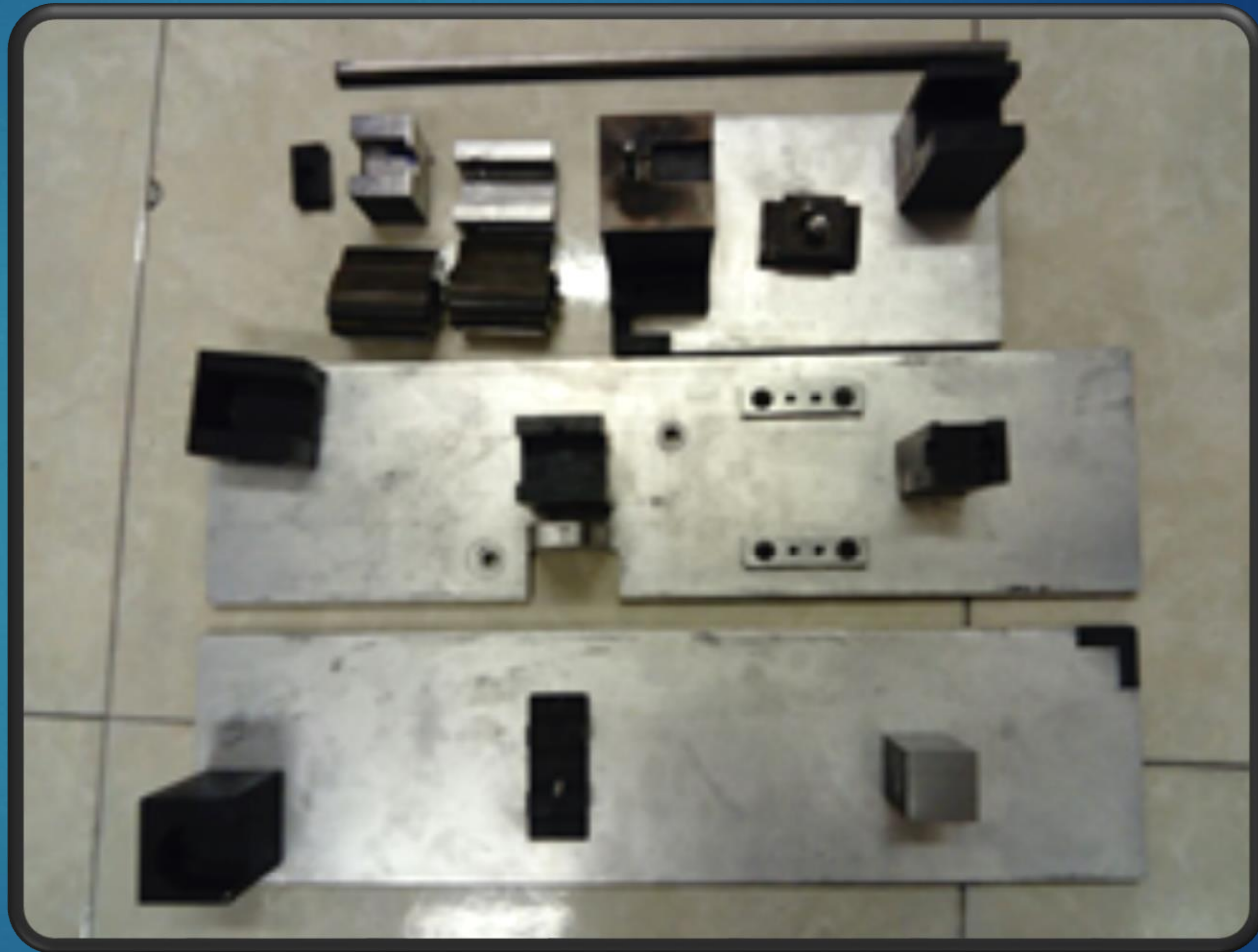

NIDO PARA VERIFICADORA DE FUERZA Y ÁNGULO (DE NAILON VERDE)

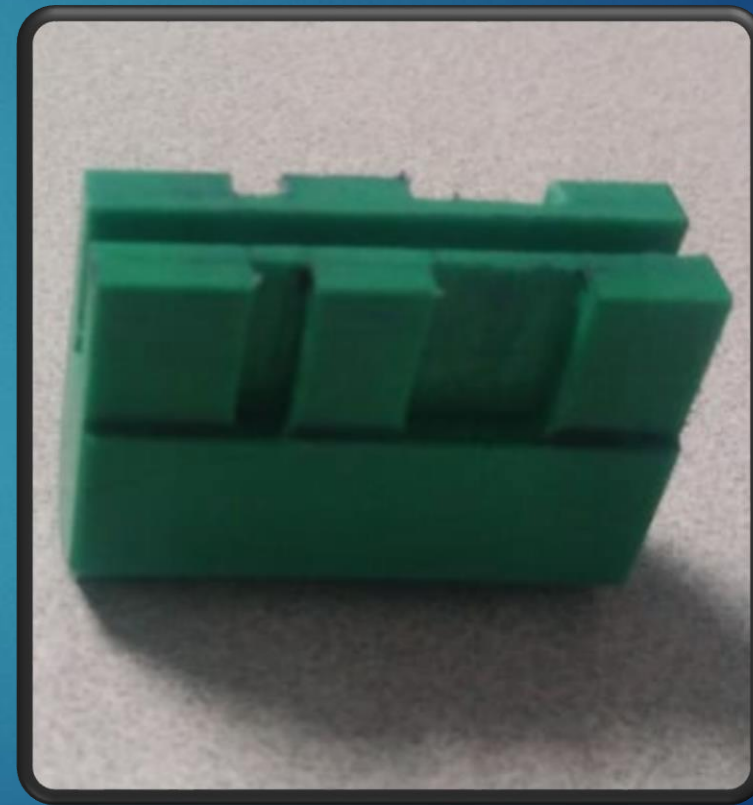

Integración De Modelo U625 Híbrido Driver



Fabricación de accesorios de acero inoxidable para ángulo.



Pieza media luna
para Dobladores
de Tubo



Factura para set up
en dobladora de
tubo para posición
de muescas



Fabricación de
racks para área
de pintura.



Fabricación de
ganchos para rack
de pinturas.



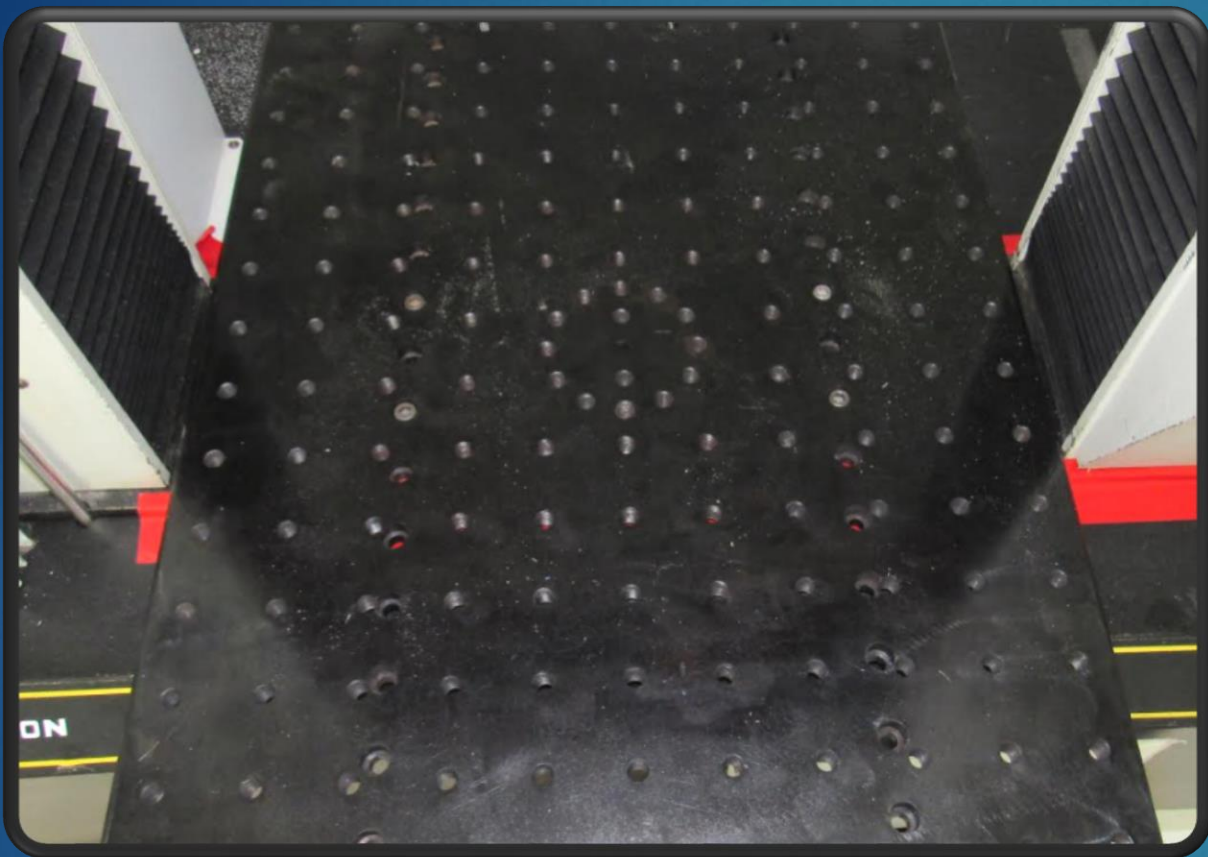

Fabricación de
base en equipo
instron para
validación de
muestras

ON



Partes de repuesto

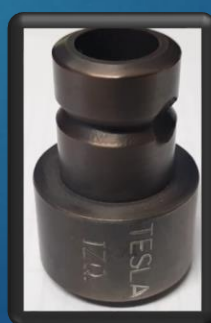

Partes de repuesto



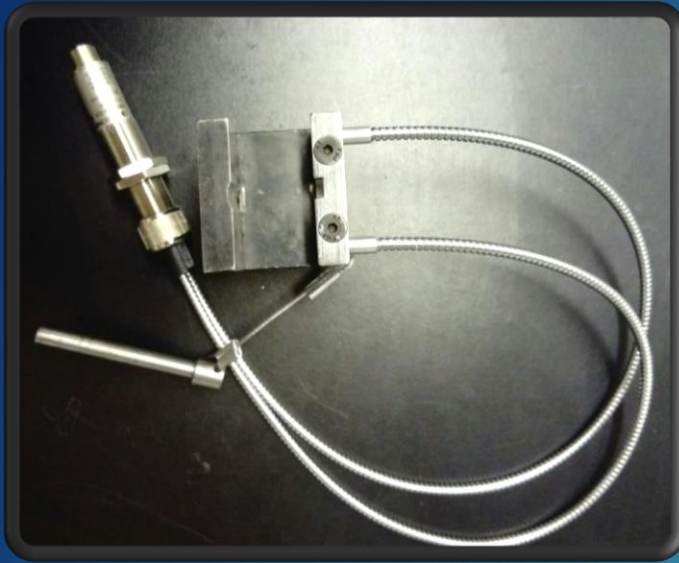

Tooling para
detección de pivote
correcto



Integración de cilindros para sujeción de sub ensamble

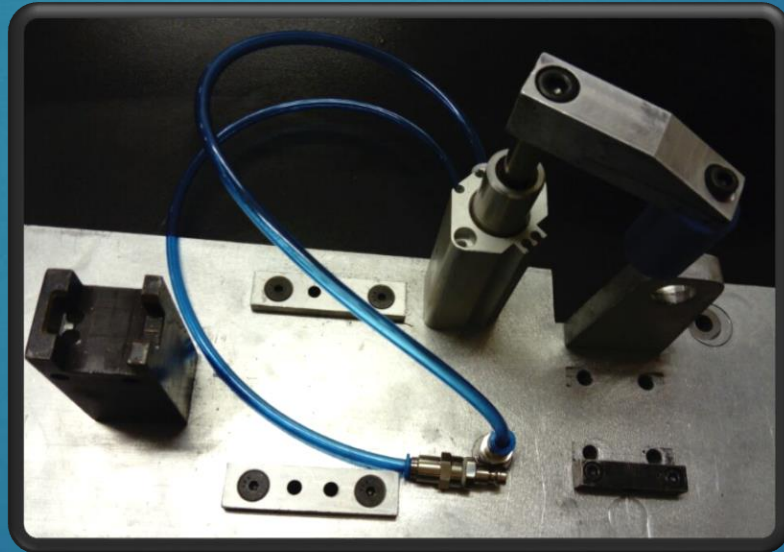

CONTACTOS

**José Luis
Velázquez
García**

Representante de ventas
Cel. 656 145-71-38
j.velazquez.sim@gmail.com

**Sergio
Holguín
Grijalva**

Representante de ventas
Cel. 656 144-10-26
Sergio.holguin.sim@gmail.com

Dirección

Calle Singapur #7430
Col. Oasis
C.P. 32697 Cd. Juárez
Chihuahua, Méx.
Tel. Oficina
656-524-65-55

